

SECTION II

TM9-2320-273-24P

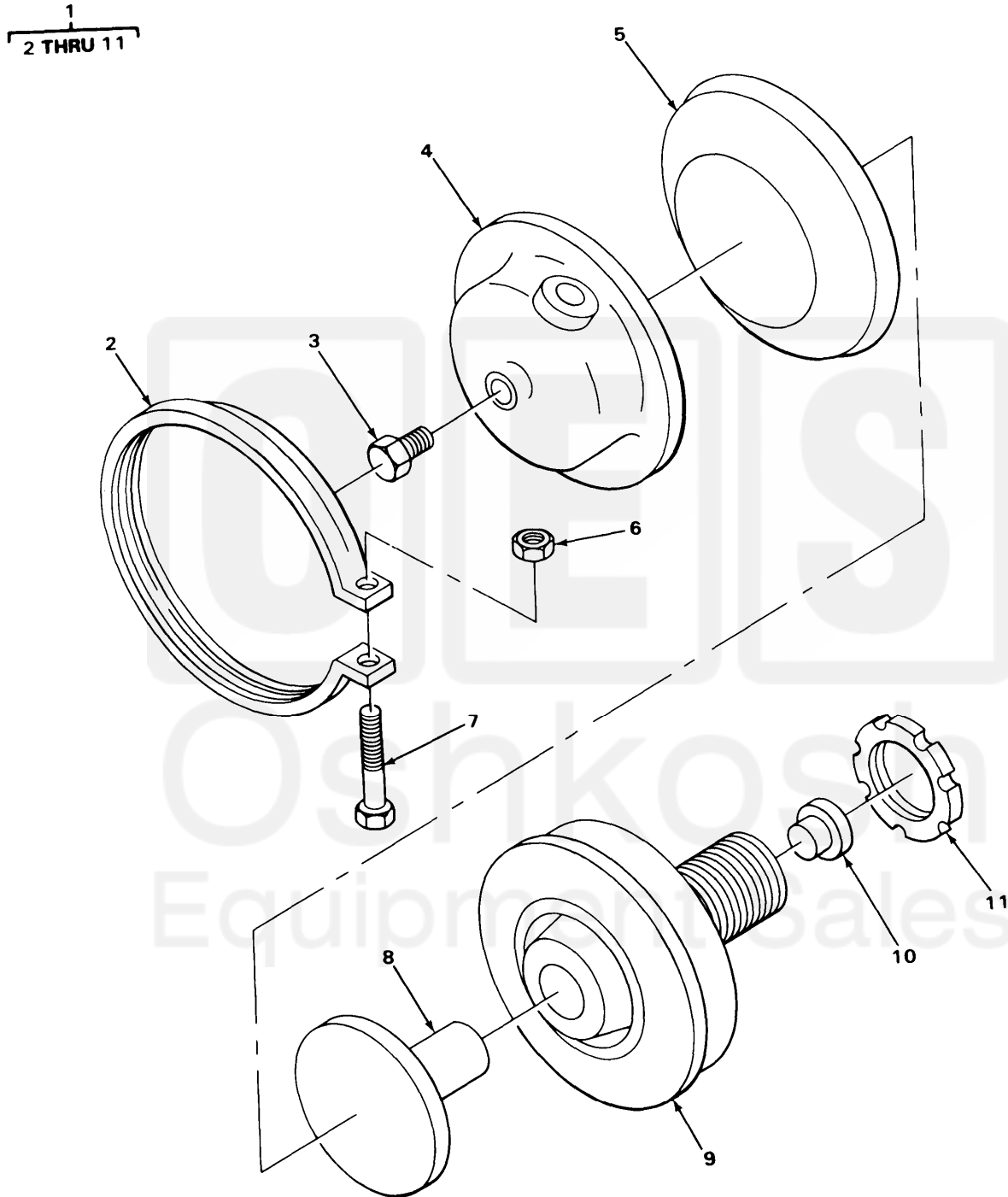

TA21711S

FIGURE 190 FRONT BRAKE CHAMBER ASSEMBLY.

Current part is item (10) on diagram. Available at [www.oshkoshequipment.com](http://www.oshkoshequipment.com)

SECTION II (1)	SMR (2)	FSCM (3)	TM9-2320-273-24P (4) PART NUMBER	(5) DESCRIPTION AND USABLE ON CODE (UOC)	(6) QTY
GROUP:1208 AIR BRAKE SYSTEM					
FIGURE 190. FRONT BRAKE CHAMBER ASSEMBLY.					
1	PAOOO	78500	Y-3276-J-10	CHAMBER,AIR BRAKE UOC:U21	1
1	PAOOO	78500	Z-55-3276-P-16	CHAMBER,AIR BRAKE UOC:U22,U23,U24,U25,U26	1
2	PBOZZ	78500	2797-X-102	.CLAMP,LOOP UOC:U21	1
2	PBOZZ	78500	2797-G-111	.CLAMP,LOOP UOC:U22,U23,U24,U25,U26	1
3	PAOZZ	78500	1199-A-3797	.PLUG,CHAMBER UOC:U22,U23,U24,U25,U26	1
4	PBOZZ	78500	A3-3780-N-66	.HOUSING ASSEMBLY,AC UOC:U22,U23,U24,U25,U26	1
4	PBOZZ	78500	A1-3780-Y-77	.HOUSING ASSEMBLY UOC:U21	1
5	PCOZZ	78500	2797-R-96	.DIAPHRAGM UOC:U21	1
5	PCOZZ	78500	2797B106	.DIAPHRAGM UOC:U22,U23,U24,U25,U26	1
6	PBOZZ	78500	N35P	.NUT,PLAIN,HEXAGON	1
7	PBOZZ	79780	15X725	.BOLT,SPECIAL	1
8	PAOZZ	78500	A38-1779-W-231	.ROD UOC:U21	1
8	PAOZZ	78500	A51-1779-X-232	.ROD UOC:U22,U23,U24,U25,U26	1
9	PBOZZ	78500	A3-3780-Q-121	.HOUSING, NONPESUR UOC:U21	1
9	PBOZZ	78500	A70-3780-S-123	.HOUSING, NONPRESSUR UOC:U22,U23,U24,U25,U26	1
10	PAOZZ	63734	1779Q433	.GUIDE,BRAKE ASSY UOC:U21	1
10	PAOZZ	63734	1779S435	.GUIDE,WEDGE UOC:U22,U23,U24,U25,U26	1
11	PAOZZ	78500	1727N40	.NUT,SELF-LOCKING,SI UOC:U21	1
END OF FIGURE					

Current part is item (10) on diagram. Available at [www.oshkoshequipment.com](http://www.oshkoshequipment.com)